

## REPLACEMENT

### REPLACE COMPANION FLANGE DUST DEFLECTOR

- (a) Using SST, a socket wrench and a press, remove the dust deflector.

SST 09950-00020

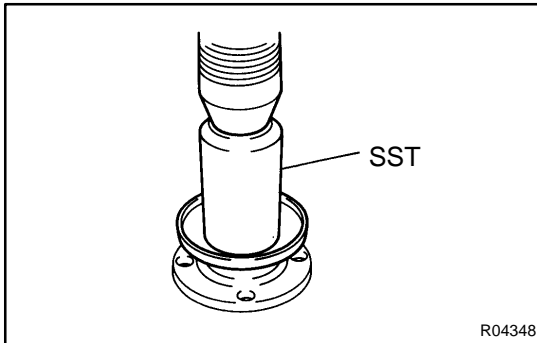

- (b) Using SST and a press, install a new dust deflector.

SST 09636-20010